

AIR HOCKEY TABLE GAME

MINI AIR HOKEJ



EN

ASSEMBLING INSTRUCTION MANUAL

CZ





NÁVOD K SESTAVENÍ

SK

NÁVOD NA ZOSTAVENIE

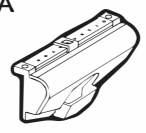
CZ/SK

Návod k sestavení / Návod na zostavenie

				
2 ks	4 ks	4 ks	2 ks	2 ks

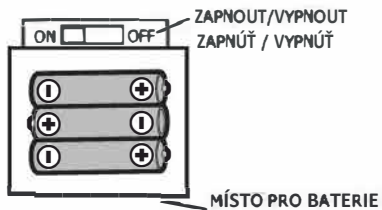
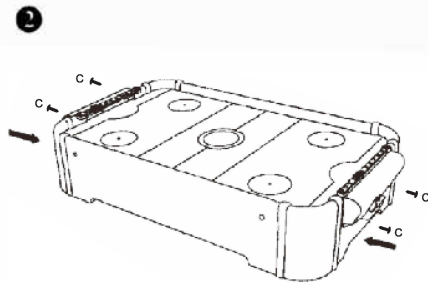
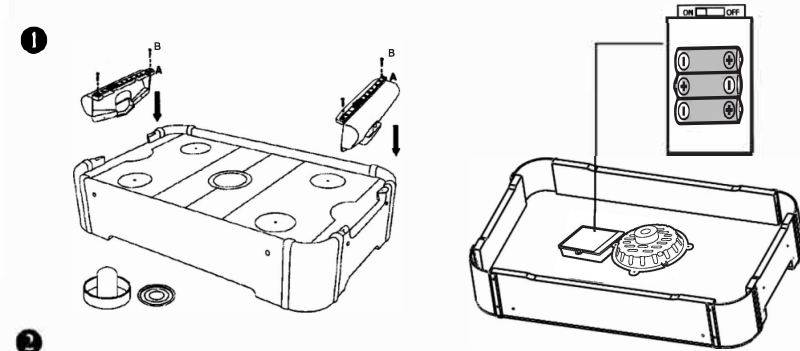



3 x AA 1.5V baterie

VAROVÁNÍ / VAROVANIE

- Nekombinujte staré a nové baterie, ani dobíjecí a alkalické baterie.
- Nevystavujte baterie plamenům, mohou explodovat.
- Vyjměte baterie ze hry, pokud ji chcete skladovat na delší dobu.
- Nekombinujte staré a nové baterie, ani dobíjecí a alkalické baterie.
- Nevystavujte baterie plameni, môžu explodovať.
- Vyberte baterie z hry, ak ju chcete skladovať na dlhšiu dobu.







VAROVÁNÍ / VAROVANIE

-  Nevhodné pro děti do 3 let.
Obsahuje malé části - Nebezpečí udušení!
-  Nevhodné pre deti do 3 rokov.
Obsahuje malé časti - Nebezpečenstvo udusení!

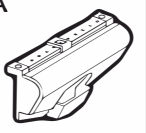
EN

ASSEMBLY INSTRUCTION

				
2PCS	4PCS	4PCS	2PCS	2PCS

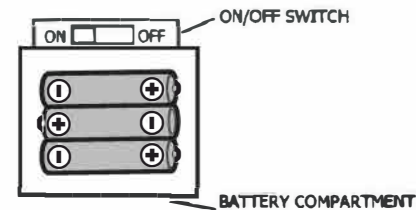
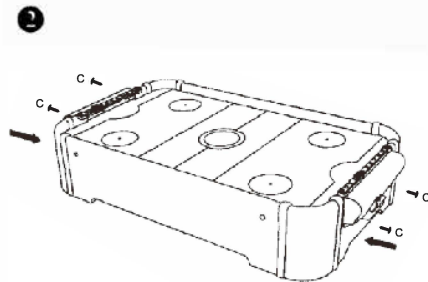
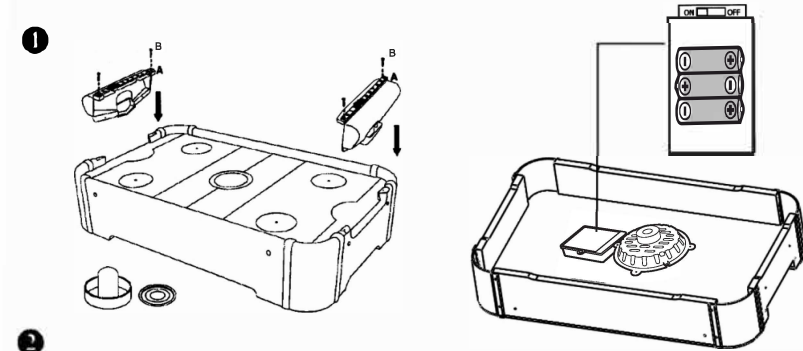

3 x AA 1.5V BATTERIES

WARNING

- Do not mix old and new batteries.
- Do not mix rechargeable and alkaline batteries.
- Do not expose the batteries to fire, they can explode.
- Remove the batteries from the game if you plan to store it away for a longer while.



WARNING

-  Not suitable for children under 3 years.
Small parts – Choking hazard!

Dovozce a distributor pro ČR:
RULYT s.r.o., 5. května 435, 440 01 Dobroměřice
www.rulyt.cz

Dovozca a distribútor pre SR:
RULYT SK s.r.o., Dolný Lieskov 195, 018 21 Dolný Lieskov
www.rulyt.sk